



STORMSTRONG
REPLACEMENT & NEW CONSTRUCTION

IMPACT RESISTANT
6100 SERIES SINGLE HUNG



Custom[®]
WINDOW SYSTEMS 

1.800.327.3086 • www.CWS.cc



STORMSTRONG

REPLACEMENT & NEW CONSTRUCTION

Impact Resistant • Single Hung Windows

Storm Strong 6100 Series Single Hung

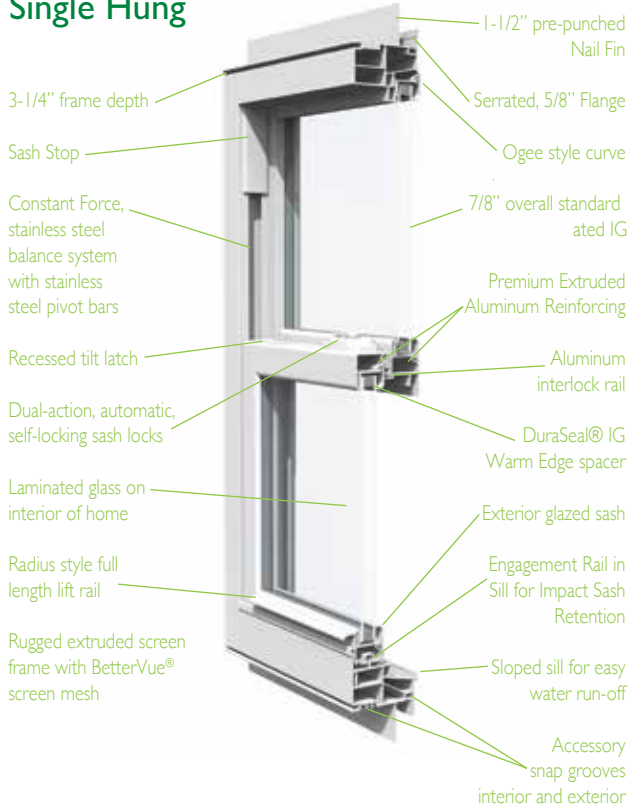

Configurations:

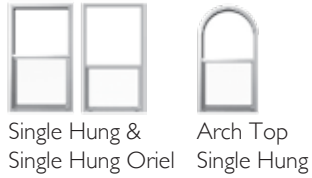

Frame Colors:

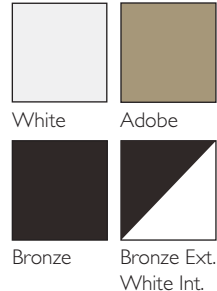

Grid Options:

Classic Applied (exterior only) Between-the-Glass



Double Applied also available (interior and exterior for depth)



6100 Series New Construction and Replacement

Specifications:

- Dual-action, automatic, self-locking sash locks
- Tilt Sash for easy cleaning

Available Frame Types:

- 1-1/2" pre-punched Nail Fin
- 5/8" serrated, double walled Front Flange
- Fin/Flange combo
- Box frame (no Fin/Flange)

Standard Features and Benefits:

- Meets or exceeds all Energy Star® standards
- Tilt Sash for easy cleaning
- Available with Low-E glass (270, 340, 366)
 - 7/8" insulated glass with argon gas standard for ultraviolet and thermal protection
 - Double-strength glass standard
- Energy efficient non-metallic spacer system
 - Excellent thermal performance and energy efficiency
 - Keeps windows clearer longer limiting condensation
- Constant Force stainless steel coil balance system
- Recessed tilt latches
- Durability and resistance from the elements
 - Fusion-welded construction without fasteners for structural stability
 - Heavy-duty weather-stripping at all points, where vinyl meets vinyl, protects against the elements
- BetterVue® half screen standard
 - Roll form or extruded screen available
 - 10% better insect protection—20% better airflow—10% clearer view
 - BetterVue® screen will not rust, corrode or stain
- 6150 Series Picture Window to complement the 6100 SH
- Maximum sizes: 53.125" x 76"



6100 Series Automatic Self-Locking Sash Locks



1900 SW 44TH AVENUE
OCALA, FL 34474
1.800.327.3086 • www.CWS.cc

All trademarks where denoted are marks of their respective owners. Registered Custom Window Systems, Inc. All rights reserved.



**STOREFRONT ENTRY
 DOOR SE3550**
➤ GLASS

- 3/16" Laminated
- 1 1/4" Laminated insulating
- High performance low-E & tints

➤ SINGLE AND DOUBLE DOORS

- Max Door Sizes 48" x 120" or 96" x 120"
- Outswing configurations
- With optional transoms

➤ DESIGN PRESSURES,

up to +90/-120, provide security, safety and performance in wind-borne debris areas

➤ STANDARD THREE-POINT LOCKING SYSTEM

with two-point on inactive side

➤ White, bronze or clear anodized finishes available

–Optional custom colors

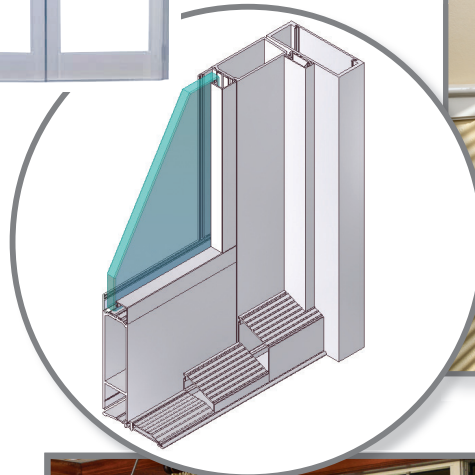
➤ Designed to be used in tandem with the SS3500 and SS3520
➤ 10" Bottom Rail for ADA compliance
➤ Many available upgrade options including panics, closers, and threshold choices



Both SS3500 and SS3520 Storefront Window Systems designed specifically to be used in tandem with the SE3550 Entry Door

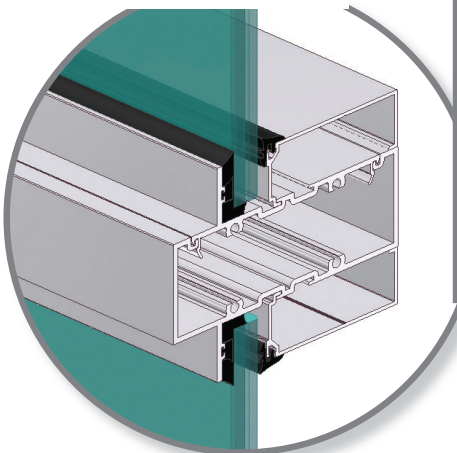

STOREFRONT WINDOW SYSTEM SS3500

- **GLASS**
 - 9/16" Laminated
 - 1 1/4" Laminated insulating
 - High performance low-E & tints
- **DESIGN PRESSURES**, up to +90/-120, provide security, safety and performance in wind-borne debris areas
- **NARROW SIGHT LINES**, 1.75" x 5", increases visibility without compromising structural integrity
- **ROBUST SIZES** – up to 12' high
- **EXTERNAL WET GLAZED**, system creates an exterior barrier, reducing the worry of water infiltration. Unlike internally drained systems, water does not have an opening to enter
- **GLAZING** is fully captured on all four sides
- White, bronze or clear anodized finishes available –Optional custom colors

SLIMFRONT WINDOW SYSTEM SS3520

- **GLASS**
 - 9/16" Laminated
 - 1 1/4" Laminated insulating
 - High performance low-E & tints
- **DESIGN PRESSURES**, up to +90/-120, provide security, safety and performance in wind-borne debris areas
- **NARROW SIGHT LINES**, 1" x 5" system with Slim Sightlines
- **ROBUST SIZES** – up to 12' high
- **EXTERNAL WET GLAZED**,
- **INSIDE GLAZED**
- **GLAZING** is fully captured on all four sides, 2 part silicone DOW 983
- White, bronze or clear anodized finishes available –Optional custom colors
- No jamb anchor required

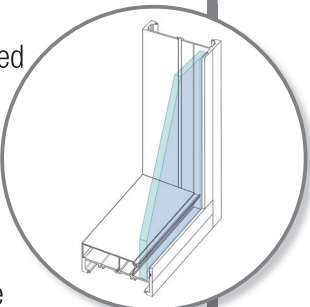



PRESTIGE
COLLECTION

**IMPACT OR NON-IMPACT RESISTANT
VINYL SWING DOORS**



Custom[®]
WINDOW SYSTEMS A logo icon consisting of a blue square with a white stylized 'C' and a green square with a white stylized 'W'.

1.800.327.3086 • www.CWS.cc

GENERAL SPECIFICATIONS

BUILT TO TAKE IT.

The Prestige Collection Swing and French Doors from Custom offers you the most unique door system available. Combining energy efficiency and structural integrity, the Prestige Collection stands alone in the industry. This door protects your home from hurricanes, intruders and high energy bills with state of the art technology and design. This door is designed and built in Florida for coastal markets and as you can imagine, a hinged door needs lots of extra engineering and structural reinforcement to outlive hurricane-force winds and flying debris. *So, despite their stylish good looks and effortless operation, our swinging hinge doors are built to take it.* ►

Complete Door System

- Single Swing Door
- French Door Double Panel
- Operable Sidelight or Unequal Operable Panels
- Outswing only
- Available in impact resistant or non-impact rated

Frame Components

- Thermally broken aluminum insulbar mainframe
- 4-9/16" frame jamb depth
- Minimal 2" clear anodize sill height
- Full length snap cover to hide install screws
- Optional 1/2" UFAS threshold sill

Panel Components

- Extruded cellulose PVC vinyl panel
- Reinforced with aluminum alloy

Performance Testing

- Impact Units are HVHZ tested under TAS201, TAS202, TAS203
- NFRC certified
- DP70 standard up to 79" x 97"
- DP60 on widths from 80"—97" x 97" high
- Energy Star® qualified configurations

Glazing

- 1" laminated insulated glass
- Exterior glazed
- Full view glass only
- Rain, Frosted and Obscure glass available
- Argon gas standard
- Available with White or Gray Interlayer
- Energy Star® rated

Sizes

- Max Swing Door: 40" x 97"
- **Max French Door: 97" x 97"**
- Max Sidelight: 36" x 97"

Up to an 8'0" x 8'0" door!



Eliminates need for sidelights

Hardware

- Adjustable hinges—vertical and horizontal
- Optional coastal brass alloy hinges
- 5 pt. (up to 81" high) or 6 pt. (over 81" high) Eurogroove multi-point lock system

Sidelights

- 5-1/2" panel width
- Simple self-mating attachment system

Warranty—Limited Lifetime

- 30 years on vinyl panels
- 10 years on aluminum frame and hardware
- Lifetime on glass (Full), prorated after 20 years
- 10 years on ChromaCote

Extra Facts

- Can withstand hurricane force winds with an impressive structural performance rating of DP +/-70
- Solid cellular PVC panels reduce the transfer of heat or cold for optimum energy efficiency
- Unique panel design provides maximum structural integrity
- Corrosion resistant hinges
- Semi-active operation comes standard with handle-activated 5 or 6 point locking system which provides for maximum security



Shoot Bolts

Wraparound, triple laminated shoot bolts activate with the multi-point locking system.



Thermally Broken Frame—Vinyl Panel

The hinges are fastened and anchored into the aluminum mainframe and penetrate through to the aluminum alloy reinforcement in the vinyl panel.

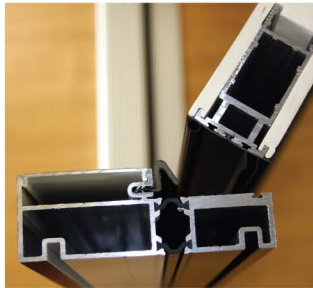

TRUE MULTI POINT SYSTEM

5 or 6 different strategically placed claws and bolts engage when the handle is activated to pull the panel tight creating a snug, tight and secure fit.

Full Adjustable Hinges

The hinges are fully adjustable in either horizontal or vertical directions to allow for simple and easy installation and for smooth, effortless operation.

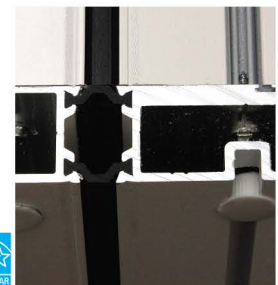

Thermally Broken Frame

The thermally broken aluminum mainframe provides strength and reinforcement for the hinges while also providing optimal thermal efficiency.

PRESTIGE DOOR OPTIONS

WIDE VARIETY OF COLOR CHOICES.

Our ChromaCote colors can be used in any combination with our color finish capabilities creating a wide variety of color choices to beautify your home. ChromaCote is a decorative surface finish that creates a bond with the frame material resulting in a durable coating which is highly resistant to scratches while requiring low maintenance.

Interior:

Dark Oak Woodgrain

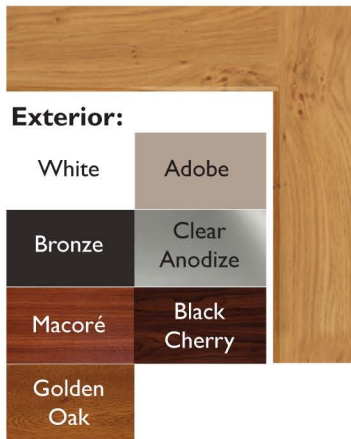

Interior:

Natural Cherry Woodgrain

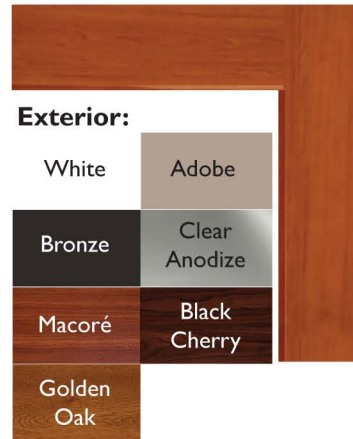

Interior:

Medium Maple Woodgrain

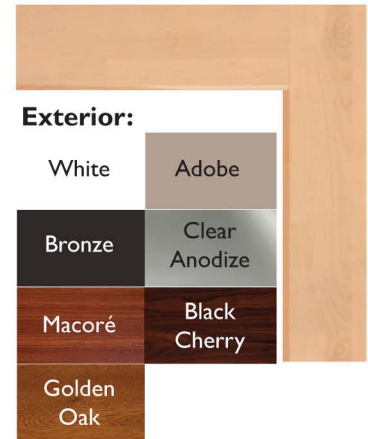

Exterior:

Macoré Woodgrain



Exterior:

Black Cherry Woodgrain

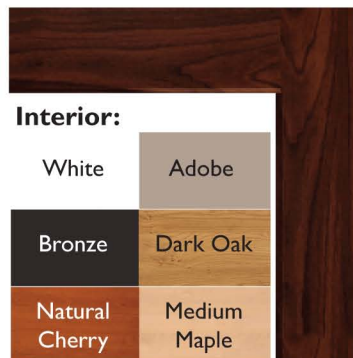

Exterior:

Golden Oak Woodgrain



Exterior:

Clear Anodize

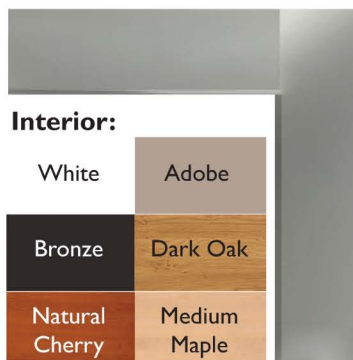

Exterior:

Bronze

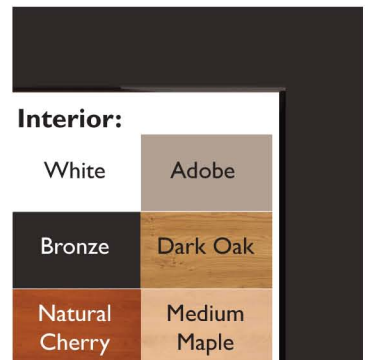

ChromaCote

Any of the ChromaCote exterior colors can also be used on the interior to give you an entire door color option.



THE PRESTIGE DOOR MEETS ALL ENERGY STAR® REQUIREMENTS.

Grid Options:

Classic Applied (exterior only)

Between-the-Glass



3/4" SDL 5/8" Flat 3/4" Contour 1" Contour

Double Applied also available (interior and exterior for depth)

Glass Colors:



Also available: Clear, Bronze, Light Gray, Sun, Azurelite Blue

Glass Finishes:



Obscure Rain Frosted

Handle Options:

Colors:



Satin Nickel Oil Rubbed Bronze Gold

Handle Styles:



Tumberry
Fusion



Stuttgart Lever
Stainless Steel



Use the link or QR code for more handle options—special order (only with 1 1/2" plate).



<http://www.cws.cc/wp-content/uploads/2014/04/Door-Handles.pdf>



Custom offers the Genius® screen (accordion style hideaway) which is retractable and is available on all of our Prestige doors, up to 16'. The Genius® screen would be ordered after your doors are installed. This screen is available for single or double doors.

GLASS TECHNOLOGY

SAVE MONEY BY CHOOSING THE RIGHT GLASS TECHNOLOGY.

In addition to enhancing the beauty of your home, windows also possess important functional features. Low-E glass reflects heat back to its source, keeping unwanted solar heat gain from penetrating your home. ►

BENEFITS

✓ Solar Control

- Decrease heat gain in your home from direct sunlight
- Control overall temperature levels year round
- Lessen energy costs from air conditioning

✓ Noise Reduction

- Reduce intrusive sounds from the outside, including traffic, aircraft and neighborhood noise

✓ UV Protection

- Laminated insulated glass blocks 99.7% of ultraviolet rays
- Protects hardwood floors and furniture from fading

✓ Insulation

- Non-conductive vinyl frame members and laminated insulated glass reduce conduction and resultant heat loss to a value far below other window frame materials.

LAMINATED INSULATED GLASS

Poly Vinyl Buteral (PVB) Interlayer

Interior →
(Laminated)

← Exterior
(Non-Laminated)

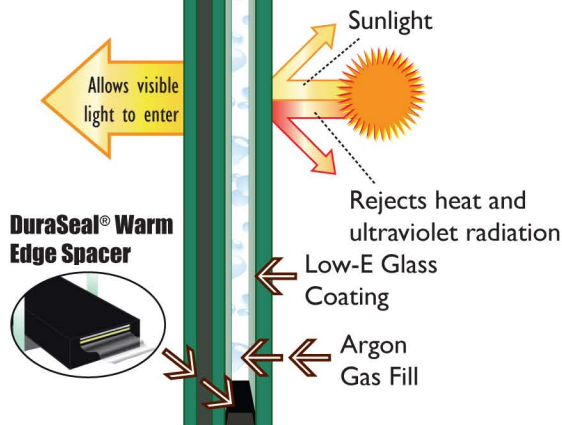

WHAT IS ARGON GAS?

Argon is a colorless, odorless, and nontoxic gas. It is inert and heavier than air. When filled in the insulating glass space, it forms a clear insulating barrier that assists in slowing the transfer of heat or cold. Custom puts argon gas in every Prestige Series door we produce as a standard feature, providing an extra insulating layer in the glass system.

LOW EMISSIVITY GLASS—EXPLAINED

The patented, state of the art sputtered coatings consist of either two or three layers of silver. These special coatings distinguish between desirable visible light against unwelcome ultra-violet rays resulting in the ultimate in solar heat and fading protection. The high transmission coatings are virtually clear, blocking the heat and reducing solar gain, while optimizing light transmission. In fact, the Low-E 270 and Low-E 366 coatings actually outperform the tinted glass often used in warm climates. In addition, because the Low-E glass transmits more natural light and reduces solar gain, you may be able to reduce both lighting and air conditioning electrical loads.

UNITS AND DIMENSIONS

8710 SIDELIGHT—8700 SINGLE PANEL

Sidelight

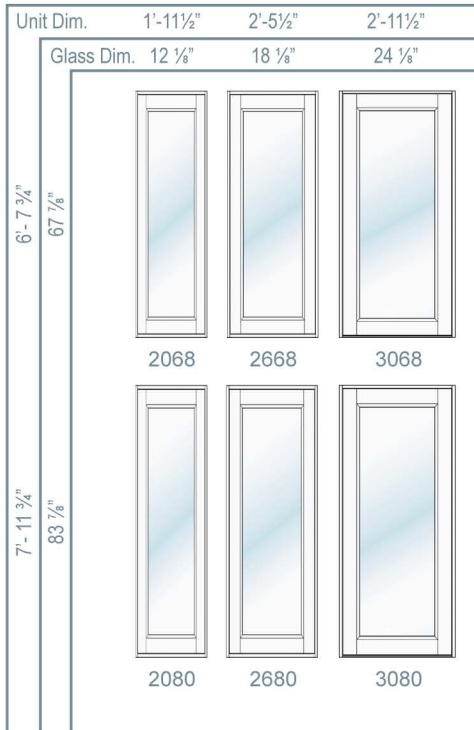

Single Panel

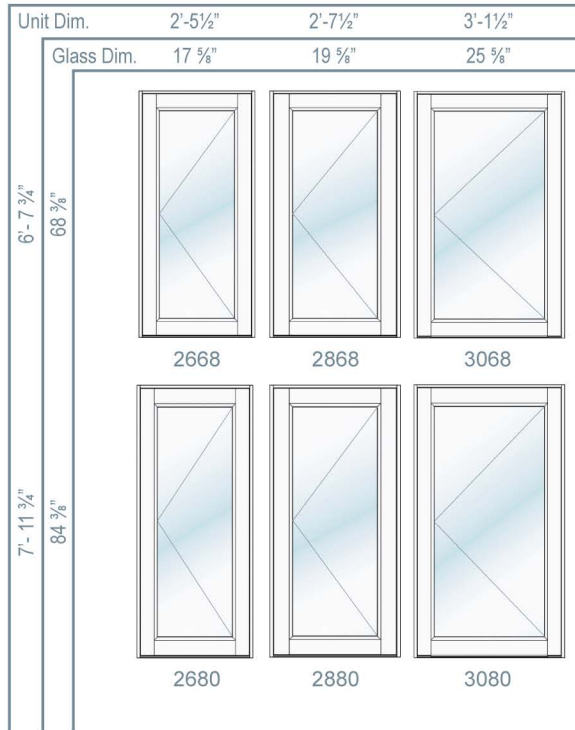

OUTSWING

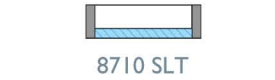
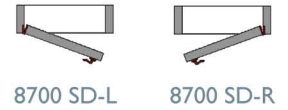

- Handing from ext. view
- Doors are not reversible

R=Hinge at right side—
exterior view
L=Hinge at left side—
exterior view

TWO PANEL CONFIGURATIONS

Two Panel

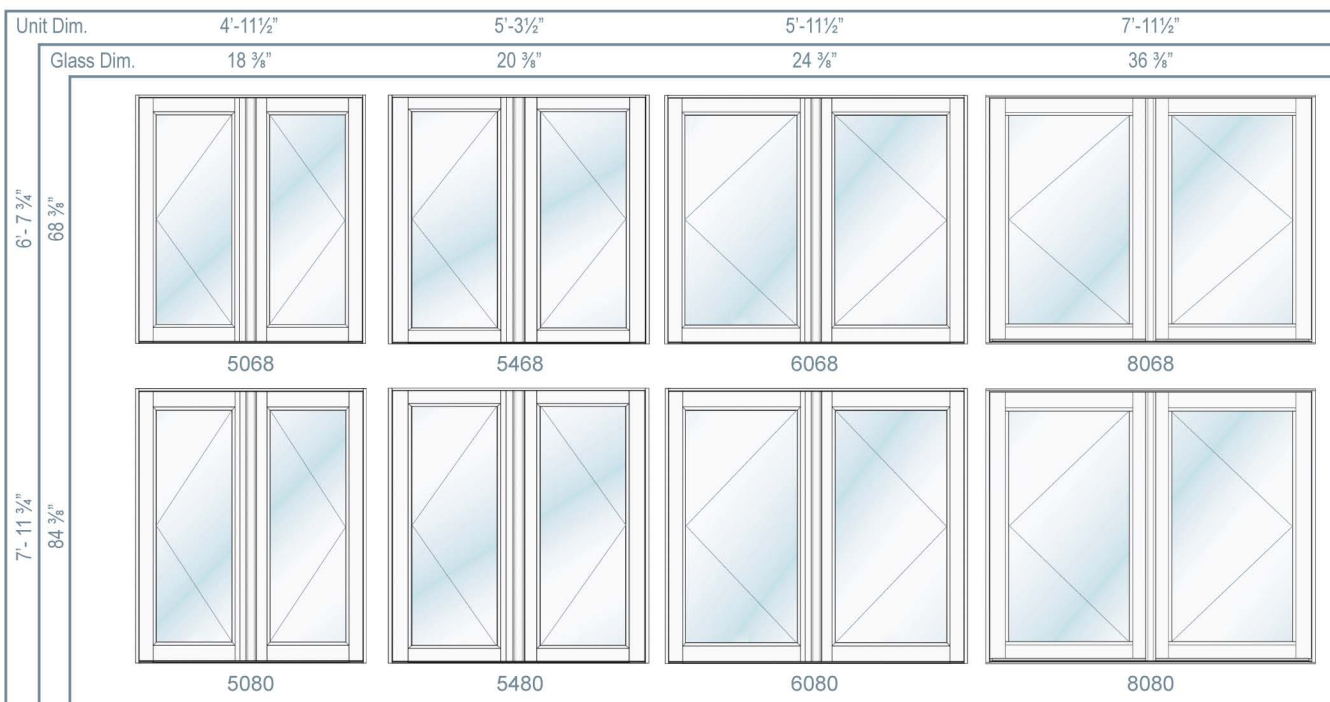



PRESTIGE COLLECTION

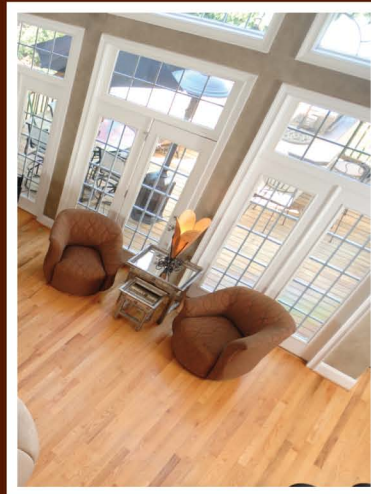
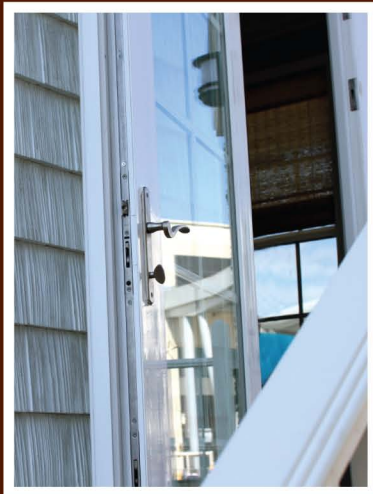

Your Custom Window System dealers are window and door professionals and are available to help you choose the best Prestige product to suit your needs.

To find the dealer nearest you, call 1.800.327.3086 or visit our website www.CWS.cc



1900 SW 44TH AVENUE
OCALA, FL 34474
1.800.327.3086 • www.CWS.cc



MONTE CARLO

FAN COLLECTIONS

5CSM60AGPD-V1: 60" Colony Super Max Plus - Aged Pewter



Dimensions:

Diameter:	60"
Weight:	22.44 lbs.
Reverse Switch:	Manual
Rev. Switch Location:	Switch Housing
Motor Size:	188.0 X 20.0
Diameter of Housing:	13.8
Capacitor Value:	4+5+6
Lead Wire Length:	78 inches
Light Kit Included:	Yes
Remote Included:	None
Remote Group(s):	CK250,NEO

Bulbs:

2 - LED Medium A19 9.3w Max. 120v - included

Features:

- Flush mount hardware is included
- This advanced LED technology is carefully designed and selected to consist of the highest quality LED chipsets for superior performance and reliability.
- Fixture is operated with a pull chain
- This product complies with TSCA Title VI

Collection: Colony Super Max Plus

UPC #:014817595741

Finish: Aged Pewter (AGP)

Blade Finish: Light Grey Weathered Oak

Blade Finish 2: Undefined

Material List:

Safety Listing:

Safety Listed for Damp Locations

Instruction Sheets:

English (5CSM60XXXD-V1-CUL-ENG)
French (5CSM60XXXD-V1-CUL-CF)

Shade / Glass / Diffuser Details:

Part	Material	Finish	Quantity	Item Number	Length	Width	Height	Diameter	Fitter Diameter	Shade Top Length	Shade Top Width	Shade Top Diameter
Glass	Glass	Undefined	1									

Blade Details:

Blade Group	Diameter	Included	RPM Hi	CFM Hi	Watts Hi	Amps Hi	RPM Med	CFM Med	Watts Med	Amps Med	RPM Low	CFM Low	Watts Low	Amps Low
	60	Yes	148.0	5510.0	72.0	0.58	94.0	4457.0	35.6	0.44	66.0	3055.0	19.4	0.34

Mounting Options:

Mounting Type	Included	Item	Downrod Length	Downrod Diameter	Overall Height	Blade to Ceiling	Min. Ceiling Height	Canopy Style	Canopy Diameter
Downrod (Included)	yes		4.5	0.5	18.5	11.5	7.96	Dual Mount	5.15
Flush (Included)	yes				14.7	9.8	7.82	Dual Mount	5.15

Replacement Bulb Data:

Product #	Type	Base	Watts	Watts Consumed	Volts	Hours	Lumens	Temp (°K)	CRI

Shipping Information:

Monte Carlo reserves the right to revise the design of components of any product due to parts availability or change in safety listing standards without assuming any obligation or liability to modify any products previously manufactured and without notice. This literature depicts a product design that is the sole and exclusive property of Monte Carlo. In compliance with U.S copyright and patent requirements, notification is hereby presented in this form that this literature, or the product it depicts, is not to be copied, altered or used in any manner without the express written consent of, or contrary to the best interests of Monte Carlo.

Package Type	Product #	Quantity	UPC	Length	Width	Height	Cube	Weight	Fr. Class	UPS Ship
Individual	5CSM60AGPD-V1	1	014817595741	27.75	11	15.5	2.738	30.4	93	Yes
NJ Pallet		24		48	40	75	83.333	729.6		No
NV Pallet		24		48	40	70	77.778	727		No

FEATURES & SPECIFICATIONS

INTENDED USE

The OLB LED Bullet Floodlight is a long-lasting energy-efficient landscape flood light. Available with spot or flood optics making it ideal for many commercial and residential outdoor applications such lighting of landscapes, building details and flag poles.

CONSTRUCTION

Die-cast aluminum housing has integral heat sink fins to optimize thermal management through conductive and convective cooling. The LED driver is mounted in the lower housing promoting a low operating temperature and long life. Housing is sealed against moisture and environmental contaminants (IP65).

Finish: Exterior parts are protected by a thermoset powder coat finish that provides superior resistance to corrosion and weathering. A tightly controlled multi-stage process ensures a minimum 3 mils thickness for a finish that can withstand extreme climate changes without cracking or peeling.

OPTICS

Optics are engineered for superior field-to-beam ratios, uniformity and spacing. Available with 5H x 4V flood optics for illuminating larger objects or 2H x 2V spot optics for illuminating targets up to 50 feet away. Light engines are available in 3000K (80 CRI min.) or 5000K (66 CRI min.) configurations.

ELECTRICAL

MVOLT driver operates on any line voltage from 120-277V (50/60 Hz).

Light engine consists of four (4) discrete LEDs directly mounted directly to the heat sink to maximize heat dissipation and promote long life (100,000 hrs at 40°C, L82).

Driver is thermally isolated in base to promote long-life.

Operating temperature -30°C to 40°C.

INSTALLATION

Integral adjustable knuckle with 1/2-14 NPS threaded pipe facilitates quick and easy installation in a variety of mounting methods.

LISTINGS

UL Listed to U.S. and Canadian safety standards for wet locations within four feet of the ground.

Tested in accordance with IESNA LM-79 and LM-80 standards.

WARRANTY

5-year limited warranty. Complete warranty terms located at

www.acuitybrands.com/CustomerResources/Terms_and_conditions.aspx

Actual performance may differ as a result of end-user environment and application.

Note: Specifications subject to change without notice.

Catalog Number
Notes
Type

OLB

LED Bullet Flood Light

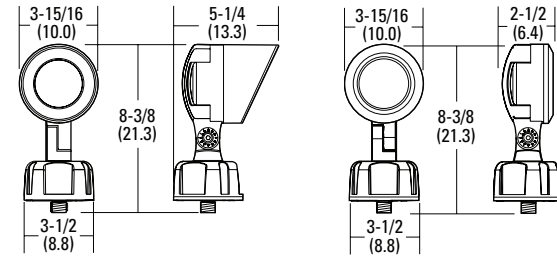

All dimensions are inches (centimeters) unless otherwise indicated.

ORDERING INFORMATION		For shortest lead times, configure product using bolded options .			Example: OLBF 8 30K DDB	
Series	Light engine	Color temperature (CCT)	Voltage	Finish		
OLBF	5x4 flood optics	8	30K 3000K	(blank) MVOLT	DDB	Dark bronze
OLBS	2x2 spot optics	8	50K 5000K	(blank) MVOLT	DDB	Dark bronze

OLB LED Bullet Flood Light

LIGHTING FACTS

To see complete photometric reports or download .ies files for this product, visit www.lithonialighting.com. Actual wattage may differ by +/- 8% when operating at 120V or 277V +/- 10%.

OLBF 8 30K DDB

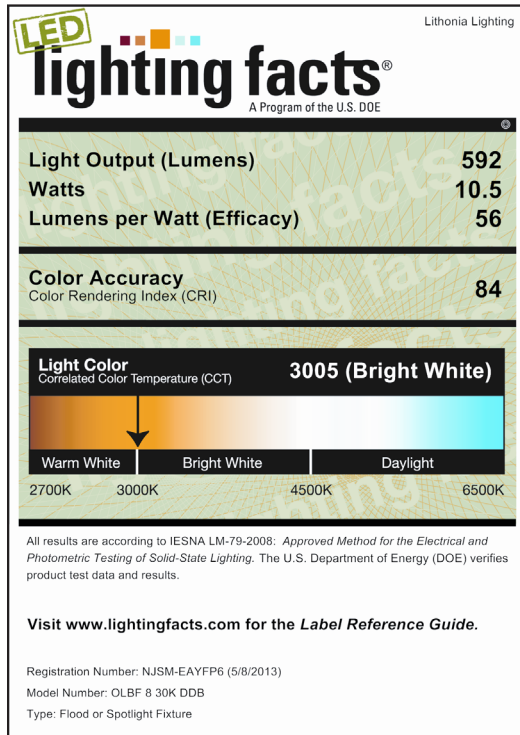

OLBF 8 50K DDB

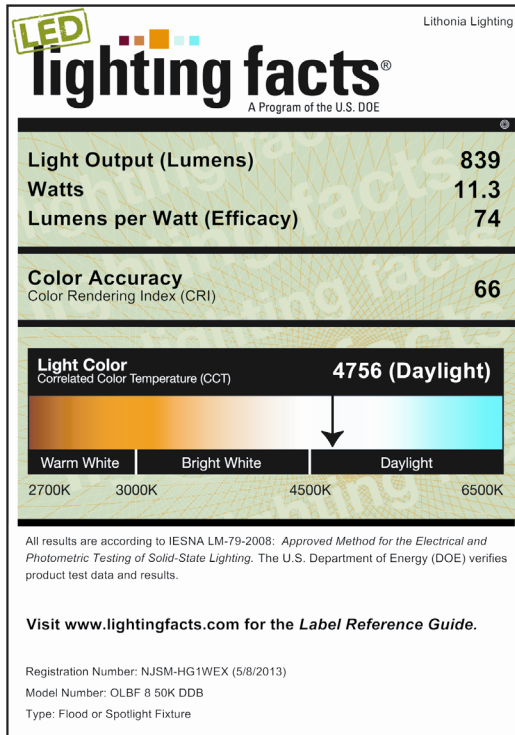

OLBS 8 30K DDB

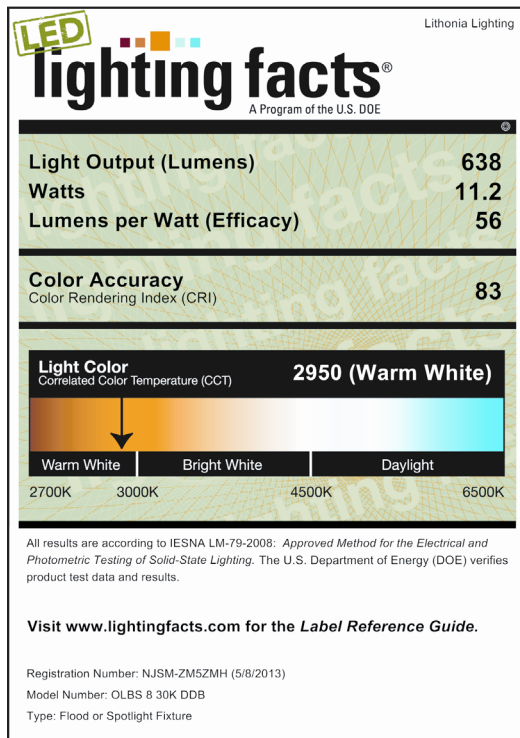

OLBS 8 50K DDB

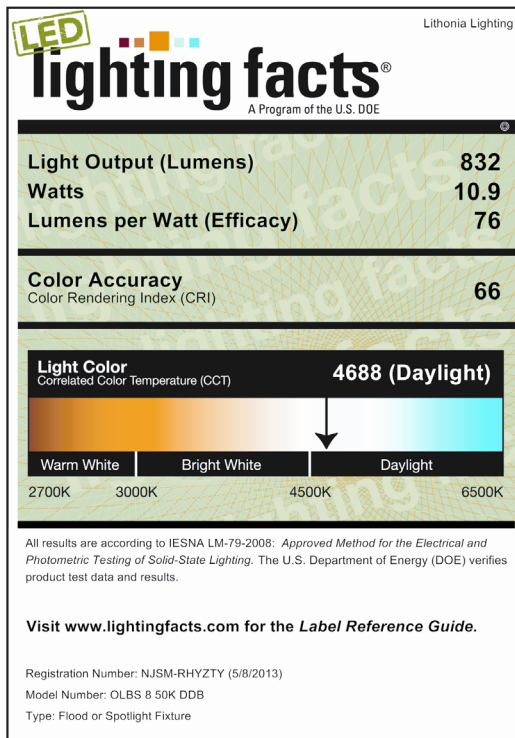





Rushmore Warehouse Pendant with 14" Shade and Three 12" Stems

PRODUCT SPECIFICATIONS

Shade Height: 8.25"
Shade Width: 14"
Stem Length: 12"
Stems Included: 3
Stem Couplers Included: 2
Overall Stem Length: 36"
Canopy Diameter: 5.75"
Canopy Height: 2"
Number of Bulbs: 1

Bulb Type: A
Max Wattage: 200
UL Listed: Yes
UL Rating: Wet
Warranty: 1 Year

AVAILABLE FINISHES

-  BRONZE (-BZ)
-  COPPER (-CP)
-  GALVANIZED (-GL)
-  SATIN BLACK (-SBL)

PRODUCT DIMENSIONS

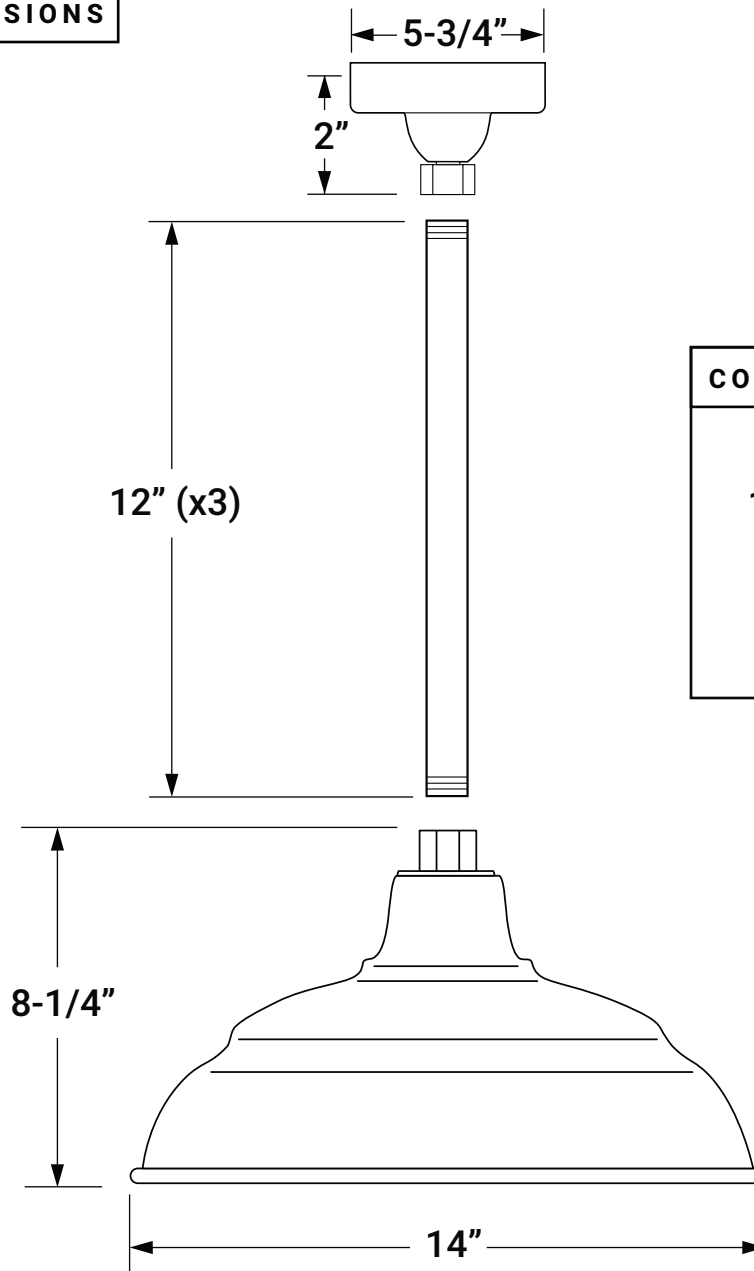

COUPLER DIMENSIONS

